

当社造船所にて作製  
 平成 2 年 11 月  
 京田造船所図面室発行

図面来

第 8 号 陽 丸  
 SNO 309  
 京 田 造 船 所 製

G/T19T 型  
 押船兼作業船兼  
 交通船

一般配置図

尺 度 1/50

一 般 配 置 図

工 務 部  
 設 計 課  
 課 長 係 長 係 長 係 長

製図年月日	平成 2 年 月 日
整理番号	
図面番号	

# GENERAL ARRANGEMENT

## S = 1 : 50

PRINCIPAL DIMENSIONS

LENGTH (O.A.)	14.800
" (NRL)	11.950
" (P.P.)	11.660
BREADTH (M.L.D.)	5.050
DEPTH (X)	1.800
DRAFT (DESIGNED)	1.500
G.T	191
MAIN ENGINE	480 P.SX2 4925-1325
SPEED	ABOUT 10.5
COMPLEMENT	1P
PASSENGER	7P
NAVIGATION AREA	SEMI COASTING AREA
CLASS	J.C.1

WHEEL HOUSE TOP

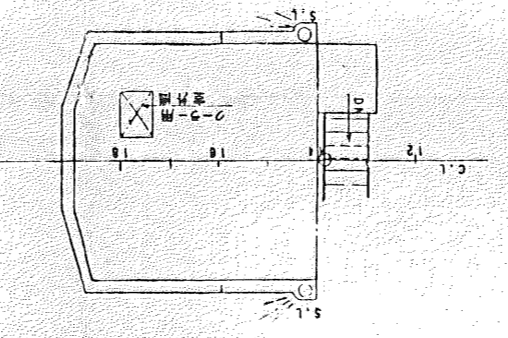

NAV. BRI. DECK

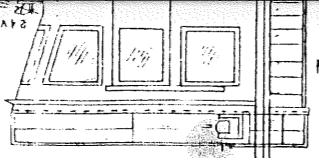
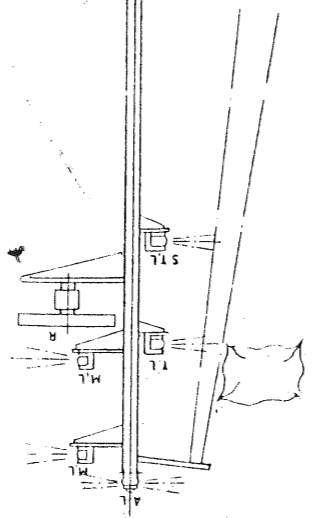
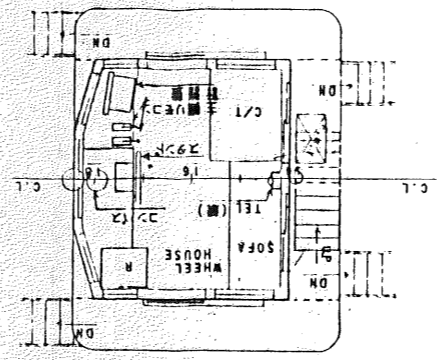

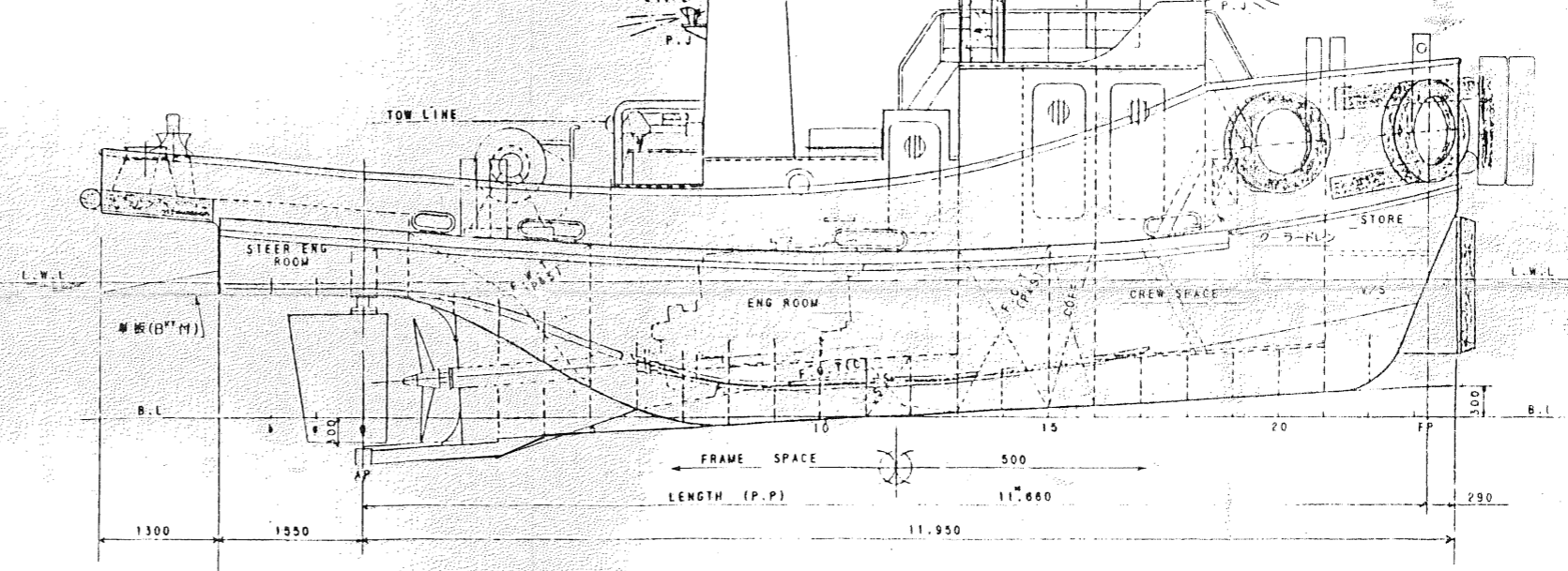

DECK PLAN

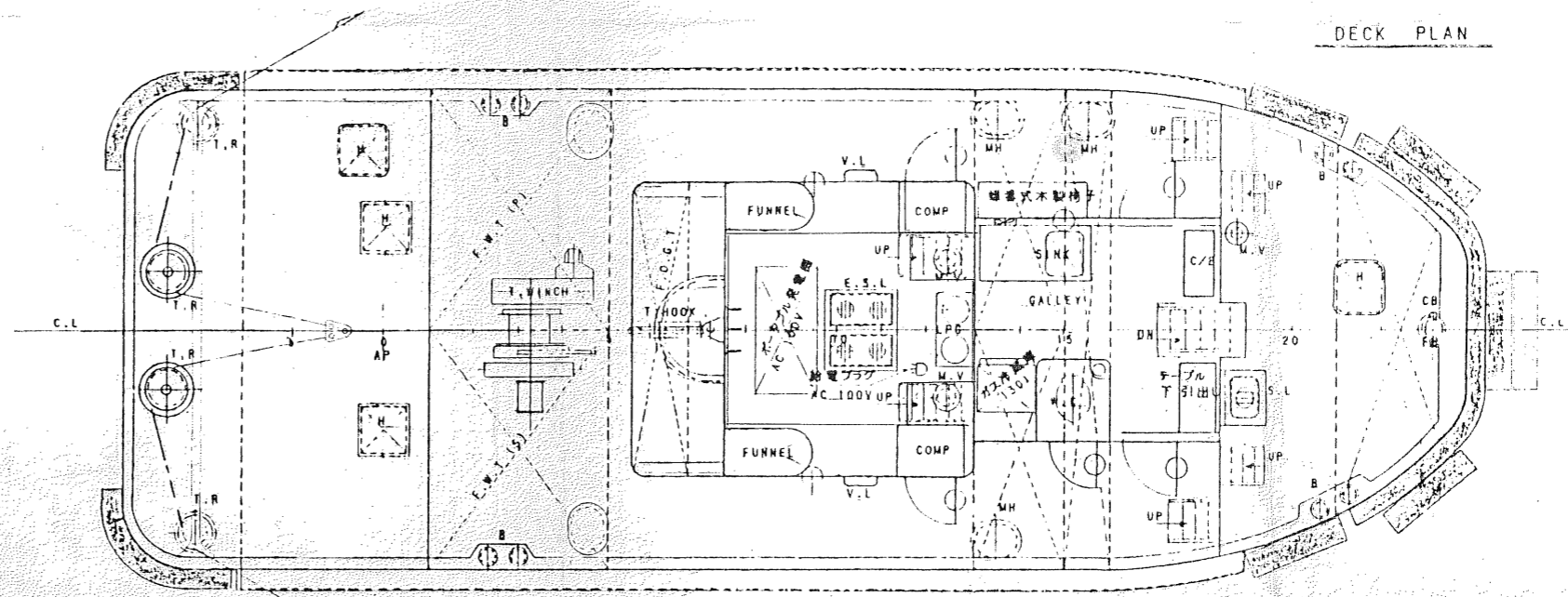

UNDER DECK

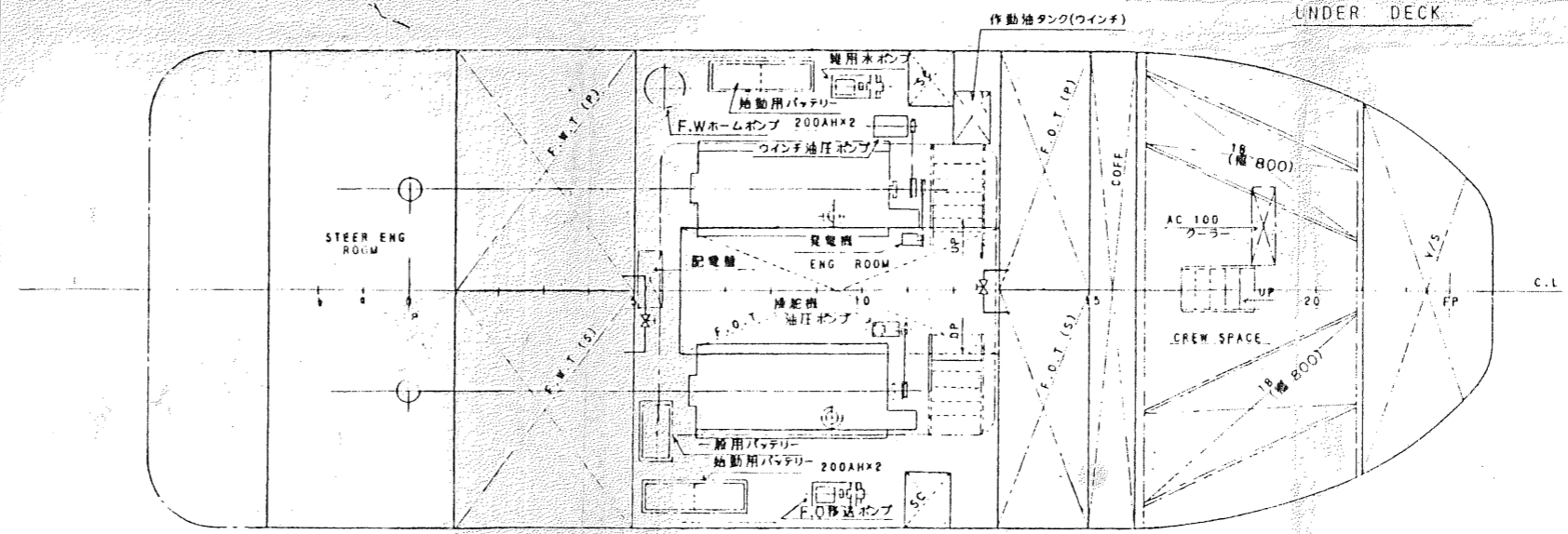

図面来歴

当社設計課にて作製  
平成 2 年 11 月  
宗田造船(株)に図面送付す。

PRINCIPAL DIMENSIONS

LENGTH (O.A.)	14,800
LENGTH (P.P.)	11,460
BREADTH (M.L.D.)	5,050
DEPTH (M.L.D.)	1,800
DRAFT (DESIGNED)	1,500
SHEER AT F.P. (C.L.)	0.800
" " " " " "	0.250
CAMBER	0.1060
RISE OF FLOOR	0.2250
FINI OF KEEL	0.330
INITIAL TRIM (BT ATT)	0.600
ORDINATE APART	1,166

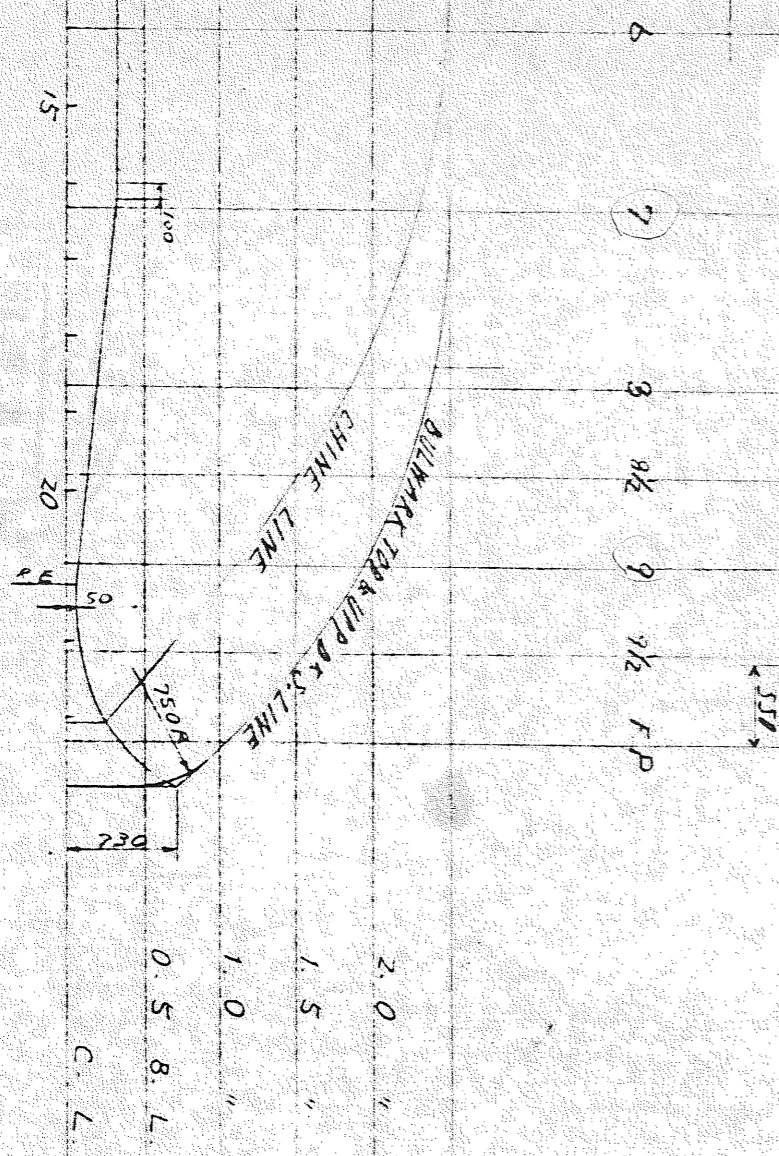
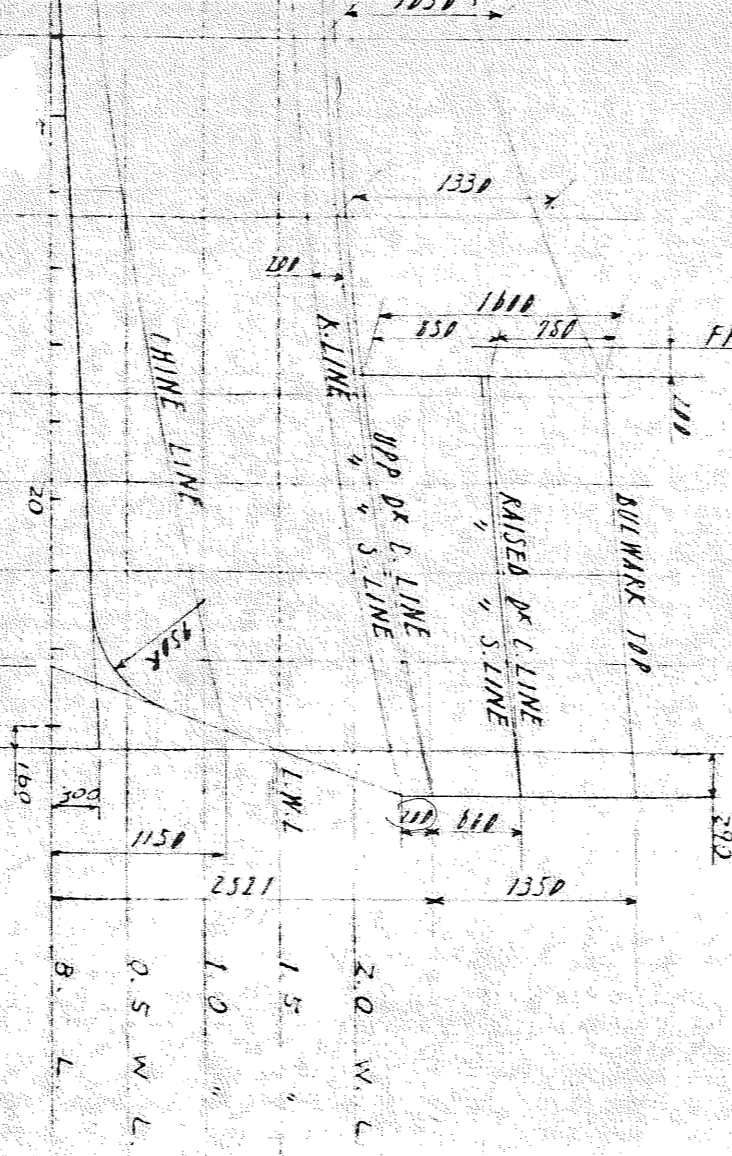
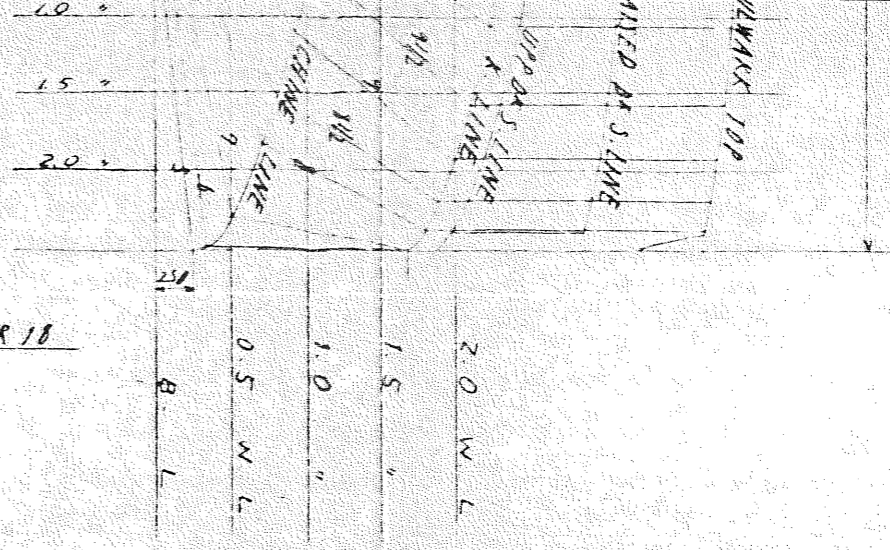

SNO 309

宗田造船株式会社

G/T19T型  
押船兼交通船

線図及船体寸法表

尺度 1/50

底押造船株式会社

工務部

社長	設計係長	製図
専務	場長	

製図年月日

整理番号

図面番号

BODY PL

OFF SET TABLE

DR NO	HALF BREADTH		HEIGHT ABOVE BASE LINE			OR NO
	KEEL LINE	CHINE UPP OF S. L.	KEEL LINE	CHINE LINE	KNUCK UPP OF S. L.	
A. E		2.525			2.201	A. E
A					2.261	A
A. P			1.33		2.19	A. P
1/2			1.31	1.31	2.003	1/2
1	0.33		1.15	1.20	1.76	1
1/2			0.85	1.01	1.925	1/2
2			0.50	0.81	1.89	2
3			0.03	0.41	1.84	3
4				0.25	1.81	4
5				0.25	1.80	5
6	0.33	2.525		0.34	1.824	6
7	0.32	2.31		0.50	1.896	7
8	0.20	1.85		0.19	1.822	8
9/2	0.14	1.51		0.80	1.908	9/2
9	0.09	1.11		0.90	2.008	9
9/2		0.65		1.03	2.123	9/2
F.P		1.06		2.49	2.449	F.P

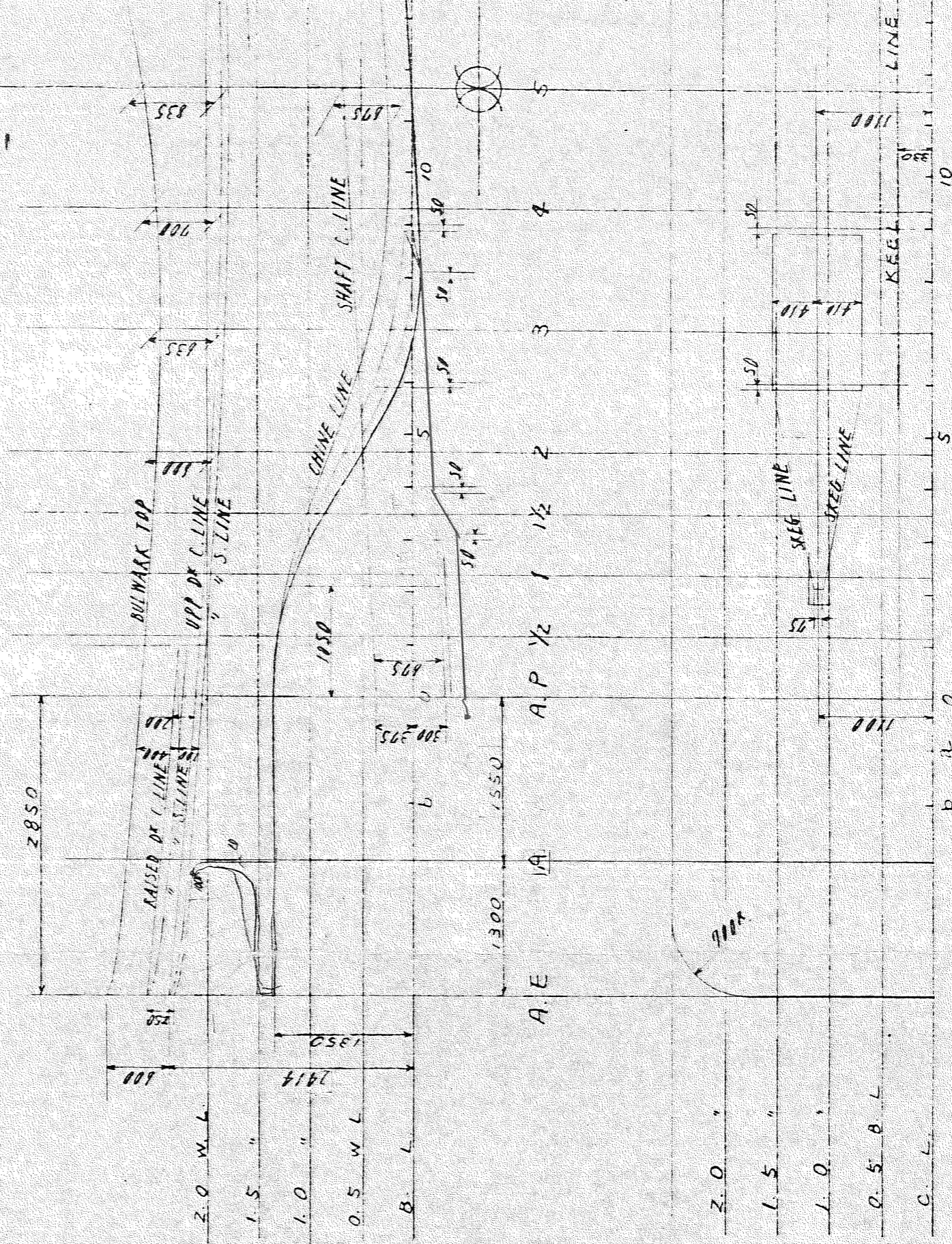
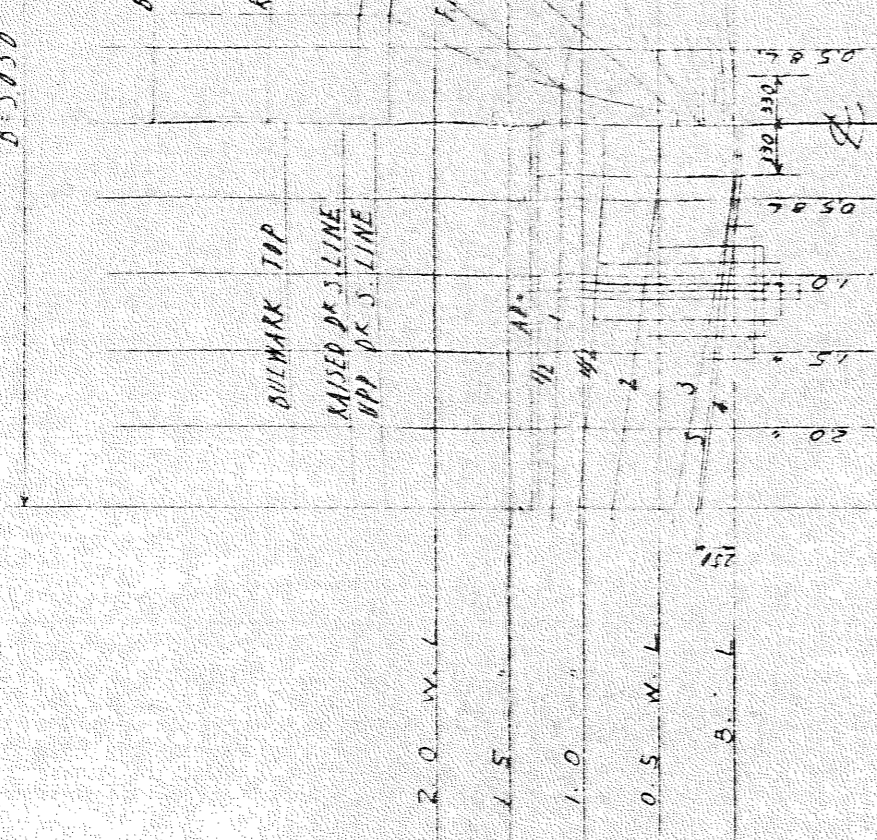

FRAME SPACE



一九三二年十一月  
 中田造船株式会社用者

MIDSHIP SECTION

(S. 130)

WE 9

FR 9 FR 12

ORDINARY

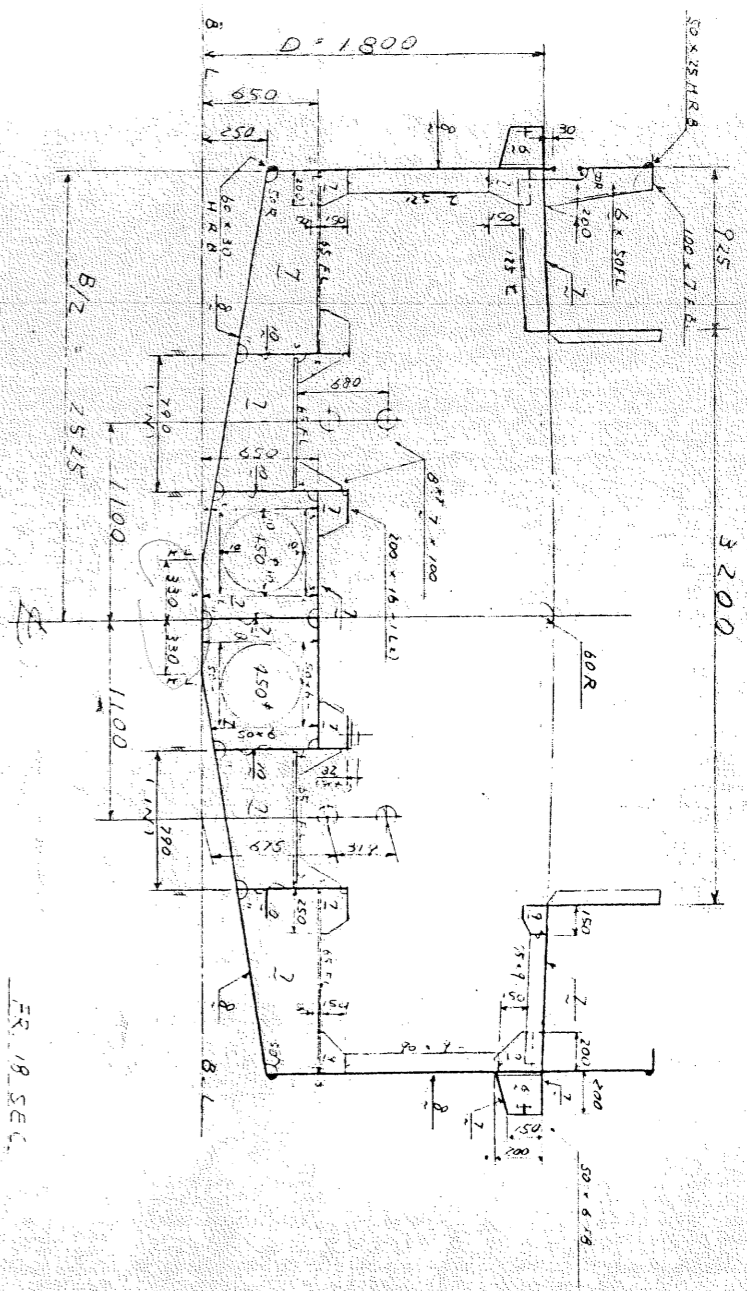

FR 18 SEC.

FR 21 SEC

STIFF 65x91.8

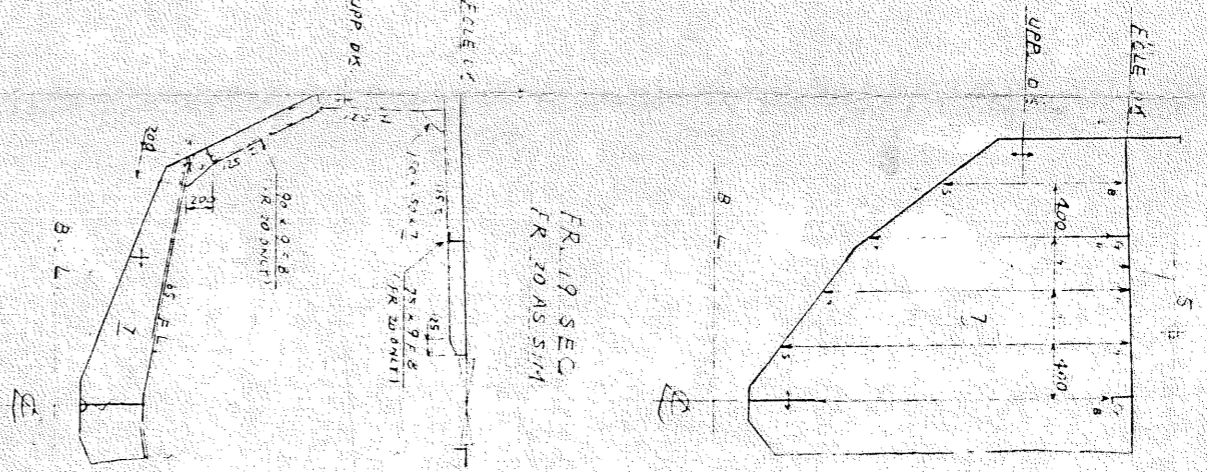

FR 19 SEC

FR 20 AS SIM

FILE 14

UPP DEK

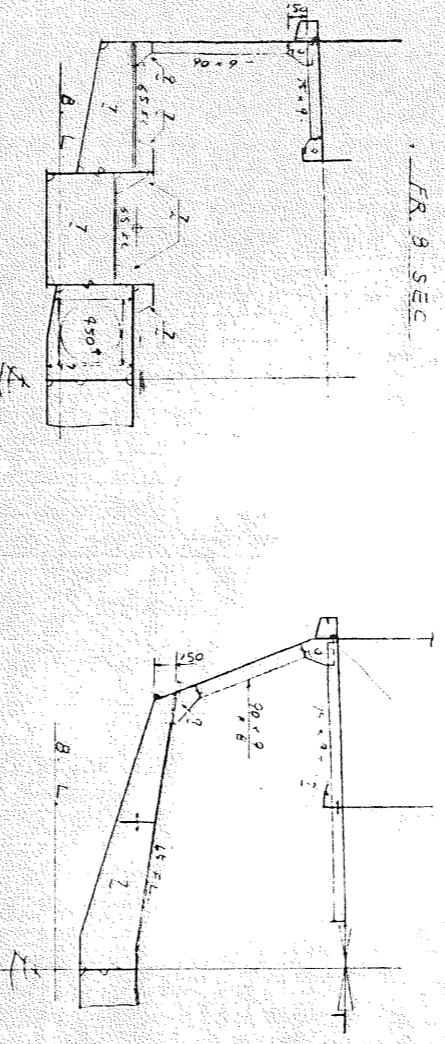

FR 7 SEC

(2) SEC

FR 16 SEC

FR 15 AS SIM

STIFF 65x91.8

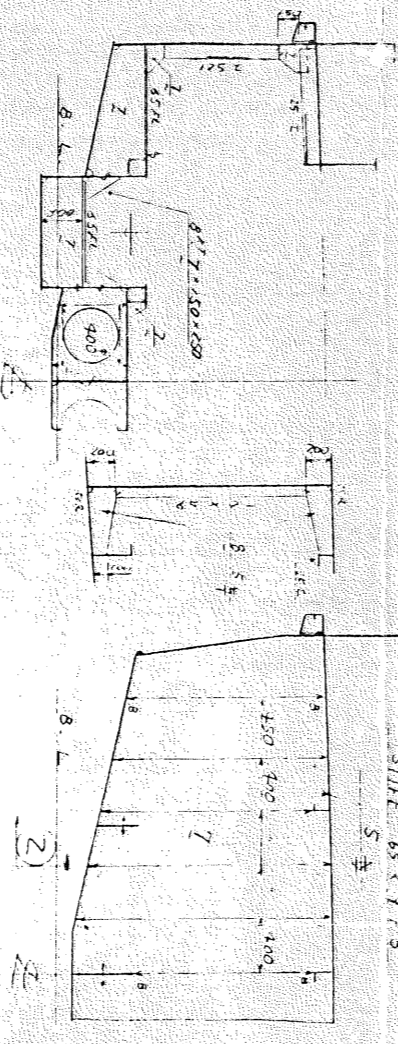

FR 6 SEC

(1) SEC

FR 13 SEC

STIFF 65x91.8

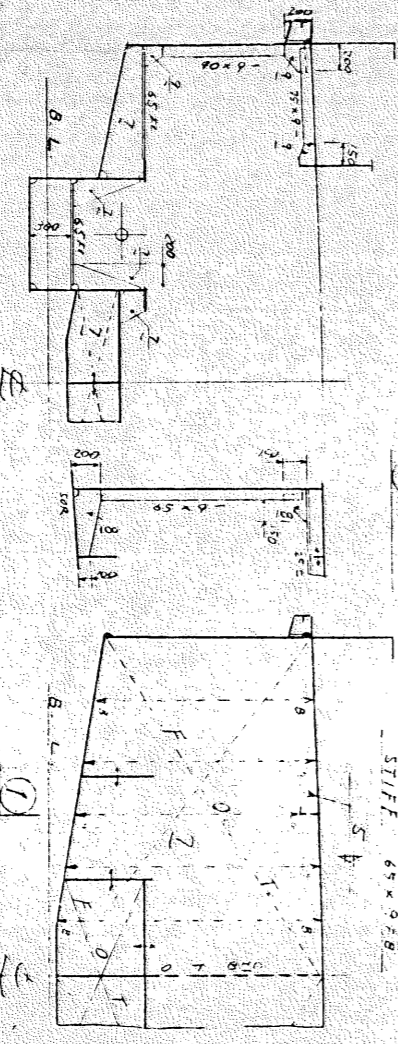

FR 5 SEC

FR 11 SEC

FR 12 AS SIM

STIFF 65x91.8

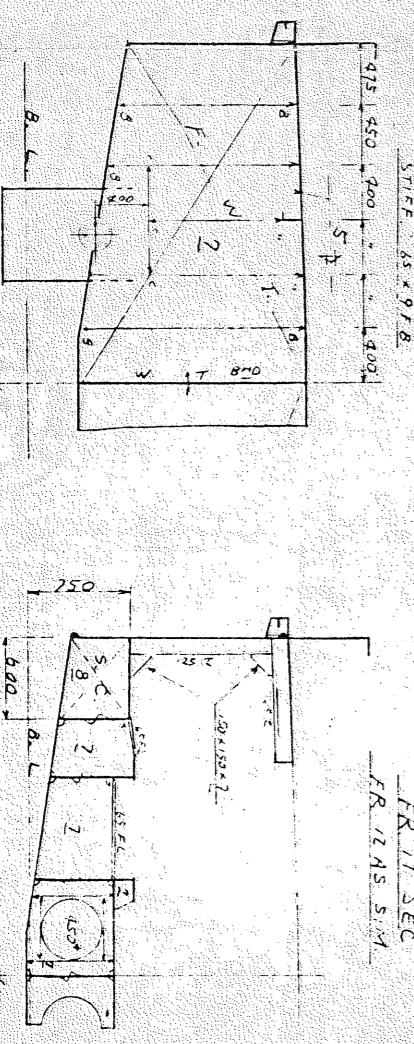

FR b SEC

FR a AS SIM

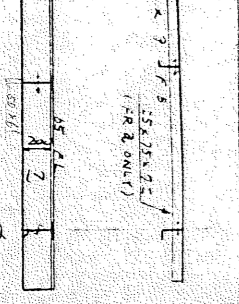

FR 1 SEC

STIFF 65x91.8

FR 2 4 AS SIM

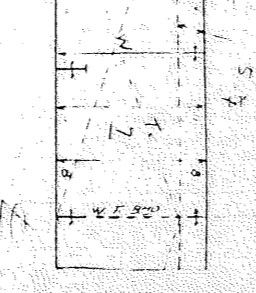

FR 0 SEC

STIFF 65x91.8

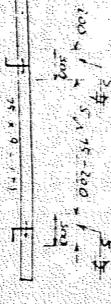

諸経向長付特記、外付

鋼材配置

G/T19T型  
 押船兼 作業船 兼  
 交通船

S.N.C. 309

中田造船株式

尺度 1/50

中田造船株式会社

工務部

社長 課長 製圖  
 製圖年月日 一九三二年 月 日  
 整理番号  
 四面番号